

# MET-TILE

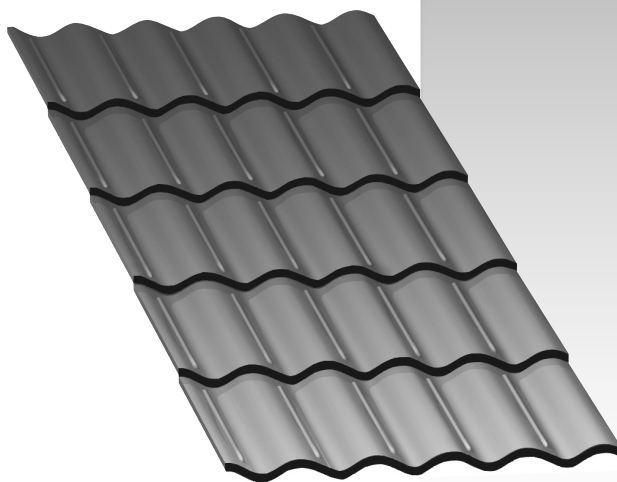

Panel / Trim / Accessories





# MET-TILE



**Met-Tile**

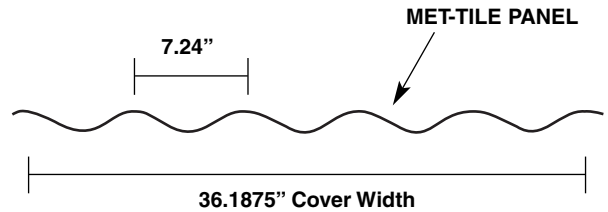

## Notes:

- Standard Panels:
  - 26 gauge Galvalume® substrate embossed with Kynar 500® coating.
- Minimum Slope:
  - 3:12 minimum roof slope with tape sealant.
- Standard minimum length is 2' and standard maximum length is 20'.
- Met-Tile panels are to be used as roof panels only.
- Met-Tile must be installed over solid deck.
- Standard trim is 26 gauge.
- Oil canning is inherent in all metal panels and is not cause for panel rejection.
- Contact a McElroy representative for specific pricing, lead times and special colors or gauges that may not be on a McElroy Metal color chart.
- Contents of this manual are subject to change without notice. To confirm this manual is the most current copy, visit [www.mcelroymetal.com](http://www.mcelroymetal.com).

## TRIM

26 GA

**Cap Trim**  
Item #: 38381

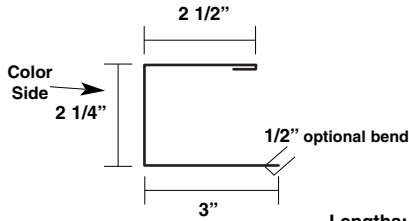

Lengths:  
10' - 3"

**Counter Flashing**  
Item #: 38382

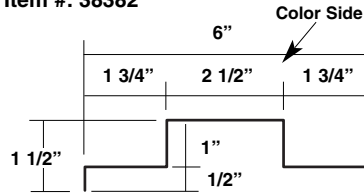

Lengths:  
10' - 3"

**Cricket / Saddle Leg**  
Item #: 38412

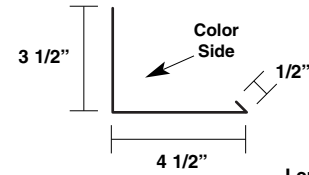

Lengths:  
10' - 3"

**Flared Edge Trim**  
Item #: 38383

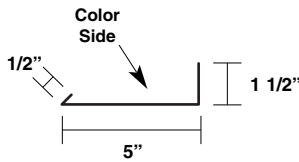

Lengths:  
10' - 3"

**Commercial Hi-Side Tie-In Flashing\***  
Item #: 38384

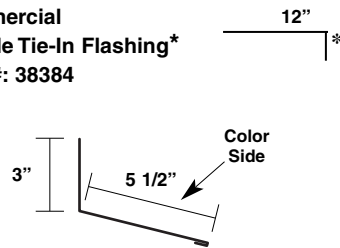

Lengths:  
10' - 3"

**Commercial Rake Flashing**  
Item #: 38386

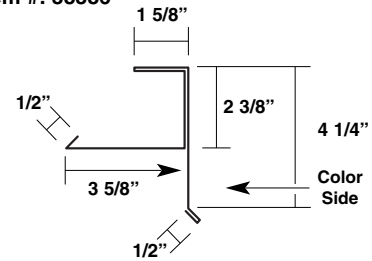

Lengths:  
10' - 3"

**Contoured Eave Flashing\***  
Item #: 38387

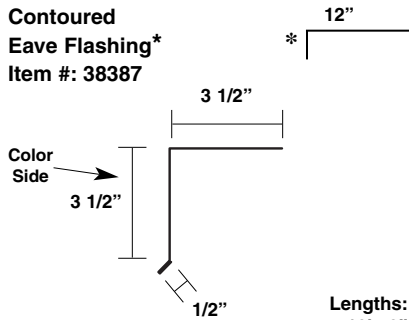

Lengths:  
10' - 3"

**Commercial Eave Flashing\***  
Item #: 38388

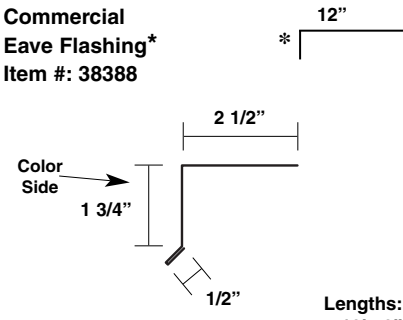

Lengths:  
10' - 3"

**Valley Cover\***  
Item #: 38389

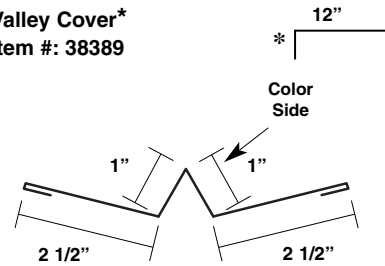

Lengths:  
10' - 3"

**Valley Pan\***  
Item #: 38390

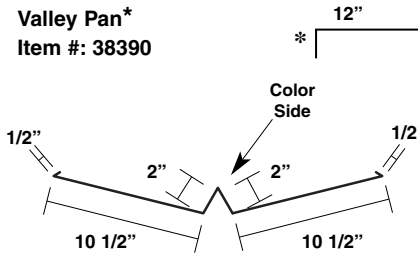

Lengths:  
10' - 3"

**Contoured Hi-Side Tie-In Flashing**  
Item #: 38396

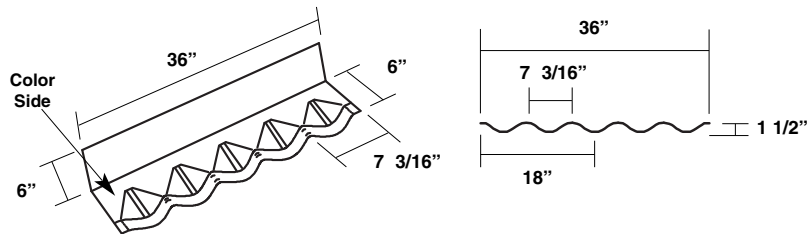

**Rake Tie-In Flashing**  
Item #: 38432

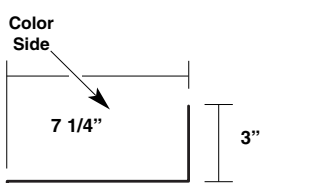

Lengths:  
10' - 3"

**Contoured Ridge / Hip Flashing**  
Item #: 38395

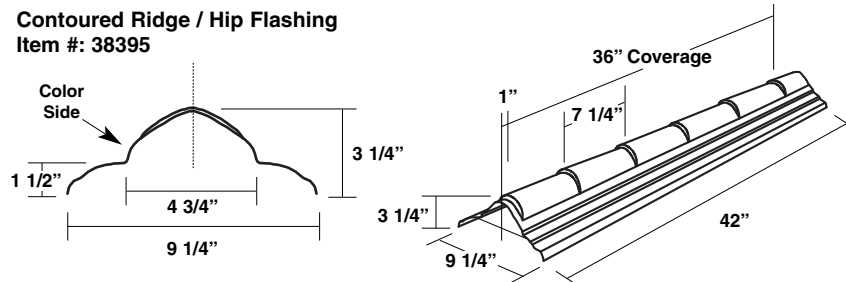

\*specify roof pitch

(H) Indicates an open hem - All other hems are closed.

# MET-TILE

## TRIM

**Contoured Rake Flashing**  
Item #: 38394

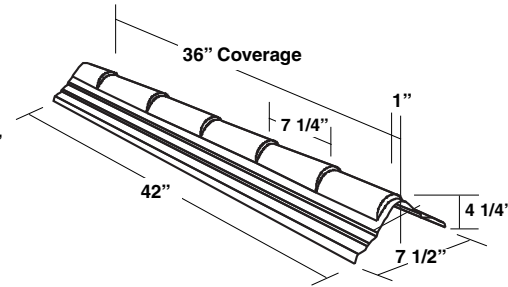
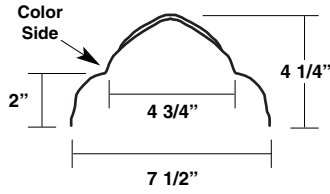

**Spanish Ridge / Hip / Rake Flashing**  
Item #: 38393

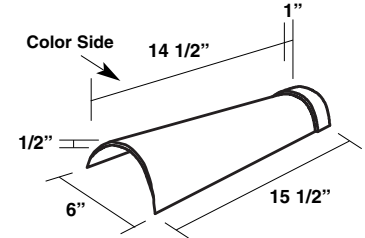

**Saddle (Finished)**  
Item #: 38418

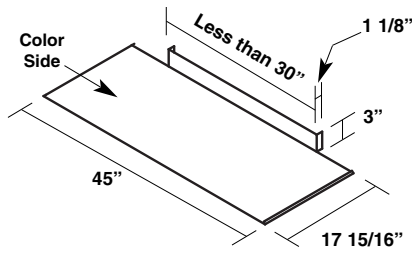

**Cricket (Finished)**  
Item #: 38417

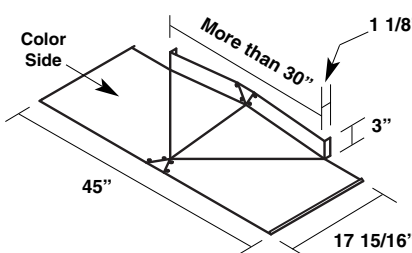

**Commercial Ridge / Hip Flashing\***  
Item #: 38419

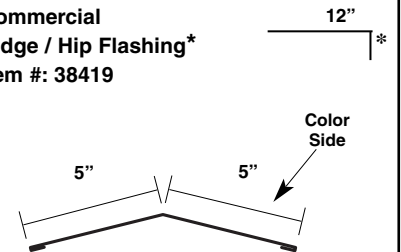

Lengths:  
10' - 3"

**Commercial Gambrel Trim\***  
Item #: 38431

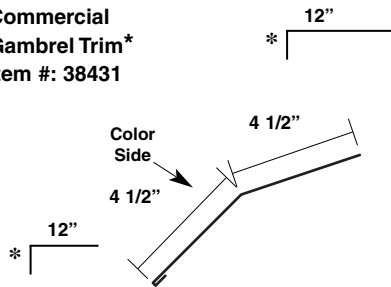

Lengths:  
10' - 3"

**Notes:**

Blank area for notes.

\*specify roof pitch

Ⓜ Indicates an open hem - All other hems are closed.

# MET-TILE

## ACCESSORIES

#9 - 15  
Type A Woodgrip  
(Part # Varies by Color)



Lengths:  
1"  
1 1/2"  
2"  
2 1/2"

1/4 - 14 x 7/8"  
LAPTEK Self Driller Sealer  
(Part # varies by color.)

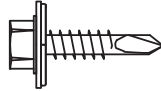

#10 - 12 x 1"  
Type A Pancake Head  
Woodgrip - Plain  
Item #: 36116

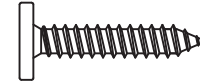

Met-Tile Touch-Up Paint Pen  
(Part # Varies by Color)



Roll Tape Sealant  
3/32" x 1" x 45'  
Item #:95335

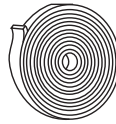

Sealskin Tape  
17/64" x 6" x 50'  
Item #: 91507

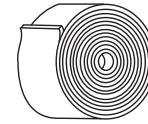

Sikalastomer Butyl Sealant  
Item #: 95342



Met-Tile Closure  
Item #: 91498

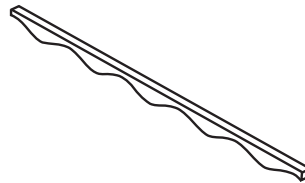

Met-Tile Universal Closure  
Item #: 91506

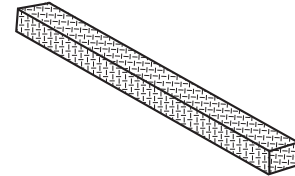

Met-Tile Bird Stop Closure  
Item #: 91555

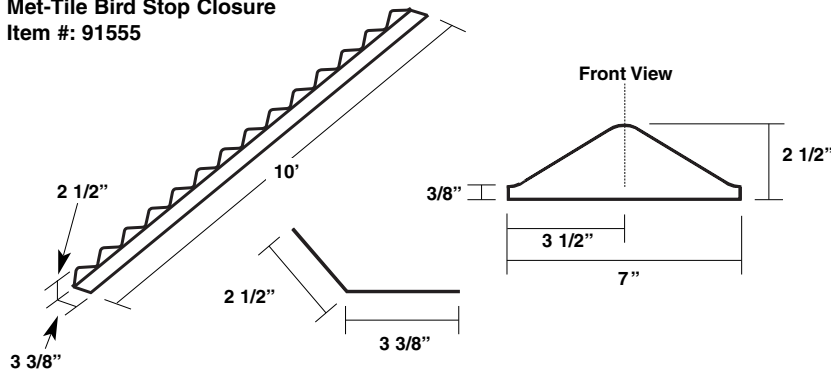

Dektite Pipe Flashing  
Item #:

1 3/4" to 3 1/4" = 97243  
 1/4" to 4" = 97244  
 3" to 6" = 97240  
 5" to 9" = 97241  
 7" to 13" = 97249

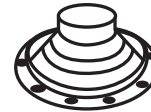





☆ MANUFACTURING LOCATIONS ● SERVICE CENTERS ★ MANUFACTURING AND SERVICE CENTER



For more information:  
**800-562-3576**  
[www.mcelroymetal.com](http://www.mcelroymetal.com)

**CORPORATE OFFICE**  
 1500 HAMILTON RD. • BOSSIER CITY, LA 71111  
 Ph: (800) 562-3576 • Fax: (318) 747-8029

**MANUFACTURING LOCATIONS**

ADELANTO, CA  
 HOUSTON, TX  
 MERKEL, TX

ASHBURN, GA  
 LEWISPORT, KY  
 PEACHTREE CITY, GA

BOSSIER CITY, LA  
 MARSHALL, MI  
 SUNNYVALE, TX

CLINTON, IL  
 MAUSTON, WI  
 WINCHESTER, VA

**MCELROY METAL**  
**SERVICE**  
 CENTER

5215 Leo St.  
 Alexandria, LA 71301

1500 Hamilton Rd.  
 Bossier City, LA 71111

3052 Yadkin  
 Chesapeake, VA 23323

9476 Meadowbrook Rd.  
 Clinton, IL 61727

3215 Highway 59  
 Diamond, MO 64840

390 N. Valley Dell Dr.  
 Fenton, MO 63026

409 Lovejoy Road  
 Ft. Walton Beach, FL 32548

3014 Lincoln Court  
 Garland, TX 75041

11625 N. Houston Rosslyn Rd.  
 Houston, TX 77086

10504 E. 59th Street  
 Indianapolis, IN 46236

9435 U.S. Hwy 60 W.  
 Lewisport, KY 42351

5123 Terminal Dr.  
 McFarland, WI 53558

514 Cave Road  
 Nashville, TN 37210

8304 Hwy. 70 E.  
 North Little Rock, AR 72117

613 North Bierdeman Rd.  
 Pearl, MS 39208

5300 83rd Street  
 Sacramento, CA 95826

1365 Dean Forest Rd.  
 Savannah, GA 31405

7355 Oakley Industrial Blvd.  
 Union City, GA 30291

1144 Silstar Rd.  
 West Columbia, SC 29170

30000 US Hwy. 69  
 Winston, MO 64689

Website: [www.mcelroymetal.com](http://www.mcelroymetal.com) • E-mail: [info@mcelroymetal.com](mailto:info@mcelroymetal.com)