



Your Metal Roofing, Siding, & Building Supplier

RETAIL CATALOG

Prices effective June 1, 2014



Phone (503) 630-7740

**FAX (503) -630-7770
1-877-773-4134**

**850 NW Park Avenue
Estacada, OR 97023**

**Email metallion.ind@hotmail.com
Website www.metallionindustries.com**

Hours: Mon. – Fri. 8 – 5:30

2' Delta Rib



- Full 24" net coverage
- Purlin-bearing edge for strength while fastening side lap
- Anti-siphoning side lap
- Custom lengths 3' through 40'0" in cut-to-length 1" increments

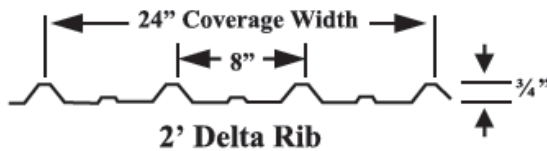

Style	Gauge	Price
Galvalume	29	\$1.50/lf.
Painted	29	\$1.90/lf.

3' Magna Rib



- Full 36" net coverage
- Purlin-bearing edge for strength while fastening side laps
- Anti-siphoning side lap
- 8 intermediate stiffening ribs add extra strength to this panel
- Custom lengths 3' through 40'0" in cut-to-length 1" increments

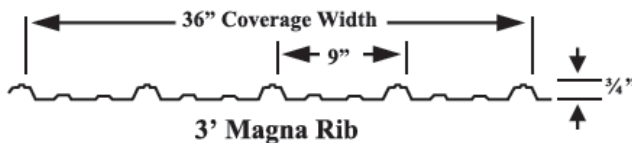

Style	Gauge	Price
Galvalume	29	\$1.65/lf.
Painted	29	\$2.20/lf.
Sale Material	29	\$1.75/lf

3' PBR



- Excellent for commercial and industrial applications
- 26 gauge full hard (80 ksi) steel
- PBR panels require a minimum slope of 1:12
- UL90 rating for PBR panels when attached to steel purlins
- Custom lengths 3' through 40'0" in cut-to-length 1" increments

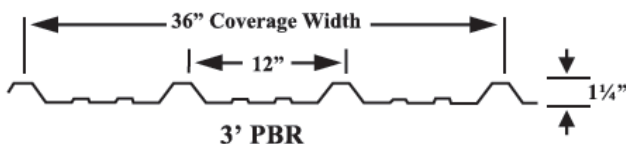

Style	Gauge	Price
Galvalume	26	\$2.10/lf.
Painted	26	\$2.95/lf.
Painted	24	\$3.75/lf
Sale Material	26	\$CALL

2 1/2" Corrugated



- 24" coverage for sidewall and 21 1/2" for roof
- Anti-siphoning side lap
- Custom lengths 3' through 40'0" in cut-to-length 1" increments

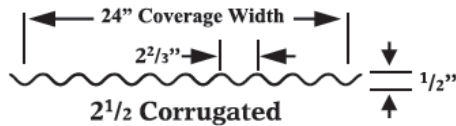

Style	Gauge	Price
Galvalume	29	\$1.50/lf.
Painted	29	\$1.90/lf.

12" or 16" Loc Seam

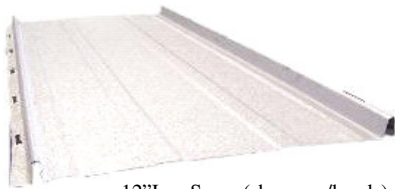

- Low maintenance and easy installation
- Residential / Architectural application
- Direct fastened - no clips necessary
- Installed over solid substrates w/felt or synthetic underlayment
- On - site roll forming
- No exposed fasteners
- Minimum slope 3/12

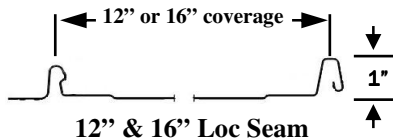

OPTIONAL: Beads or Striations

Style	Gauge	Price
12" Painted SMP	26	\$1.40/lf.
16" Painted SMP	26	\$1.75/lf.
12" Painted Kynar	24	\$1.80/lf.
16" Painted Kynar	24	\$2.25/lf.

12" Flush Panel

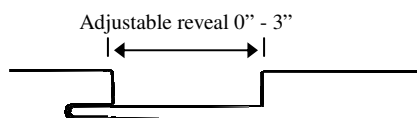
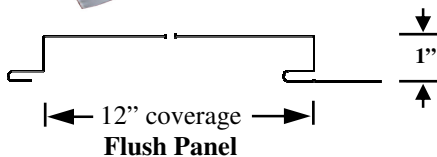

- An attractive choice for wall, fascia, and soffit applications
- Can be installed vertically or horizontally
- Concealed fastening system
- Perforations available for acoustical or vented soffit applications
- Adjustable reveal available from 0" - 3" in 1/2" increments
- Standard flat pan; available with beads or striations

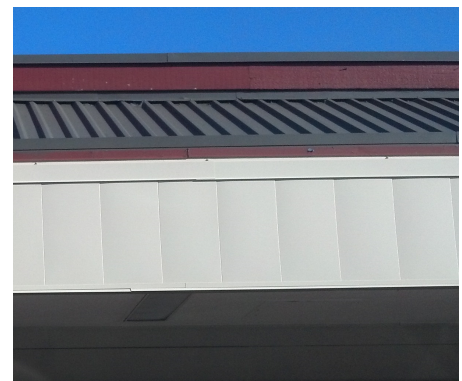

Style	Gauge	Price
12" Painted Kynar	24	\$2.00/lf

ClipLoc Standing Seam



18" ClipLoc

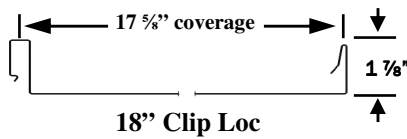

OPTIONAL: Pencil Ribs or Striations

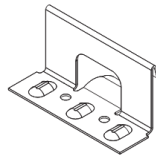

Clip

Our ClipLoc panel is a snap-together panel - no seaming required! They are engineered to exceed most wind load requirements in the country while enhancing the aesthetic appearance of a building, whether residential or commercial.

- 24 ga. Pre-painted Galvalume (22 gauge optional)
- .032/.040 Pre-painted Aluminum (plywood substrate)
- Can be installed over solid substrates, steel decking with polyiso, or in limited applications over open purlins
- Minimum slope: 2/12 - optional factory or field applied side lap sealant
- Weathertight warranty optional
- Bold 1 7/8" tall seam
- Special clip allows for full 2" of thermal movement

Style	Coverage	Gauge	Price
ClipLoc	17 5/8"	24	\$2.55 Ln Ft./ \$1.74 Per Sq. Ft.
	13 3/4"	26	\$1.80 Ln Ft./ \$1.57 Per Sq. Ft.
Clips	UL Listed		\$0.55
	Non-UL		\$0.45



SSX Seamer

Specifications:

Designed for 1-1/2" Mechanical Seam
 Front mounted auto / safety switch
 Double Lock - single pass
 Speed: 30 fpm
 Power: 7 amps @ 120 volts
 Weight: 35 lbs.
 Capacity: 26 -24 Gauge Steel
 .024 - .032" Aluminum

Mechanical Seamers

	Daily Rental	Weekly Rental
SSX Seamer	\$150	\$350
SS Industrial Seamer	\$175	\$400



SS Industrial Seamer

Specifications:

Designed for 2" Mechanical Seam
 Front and rear safety auto-shutoffs included
 Bi-directional 90° single lock seaming in one pass
 Single direction 180° double lock seaming in one pass
 Weight: 89 lbs., 24" Length
 Power: 11.5 amps @ 110 volts
 Capacity: 22 - 24 gauge Steel

Mechanically Seamed Panels

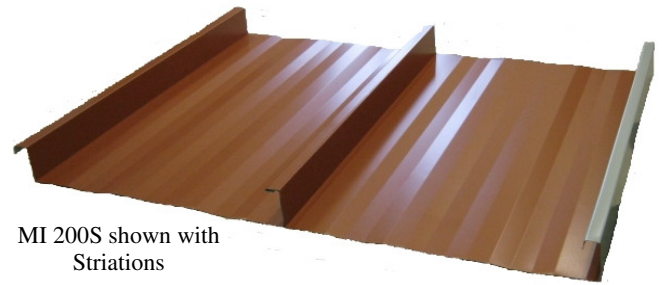
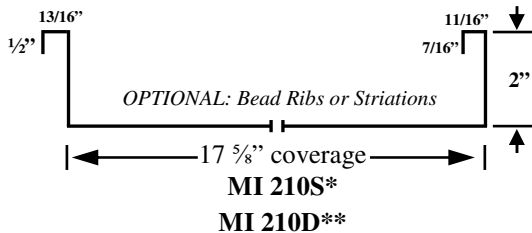
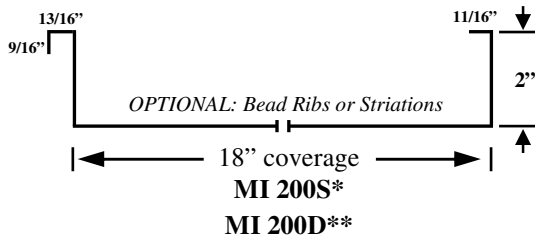
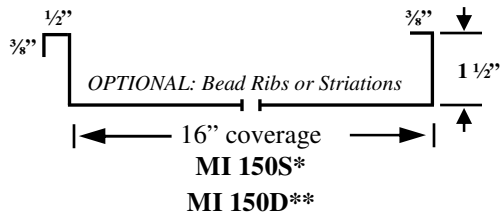

MI 200S shown with Striations

Our mechanically seamed panels enhance the aesthetic appearance of a building, whether residential or commercial. They are engineered to exceed most wind load requirements in the country and can be used to fit the needs of new construction or retrofit applications.

- 24 ga. Pre-painted Galvalume (22 gauge optional)
- .032/.040 Pre-painted Aluminum (plywood substrate)
- Can be installed over open purlins, steel decking with polyiso, or solid substrates
- Minimum slope: 1/2/12 - optional factory or field applied side lap sealant
- Weathertight warranty optional
- Single and Double Lock Seamers available
- Clip system allows for thermal expansion/contraction.



Fixed & Floating Clips



*Single Seam - 90 °

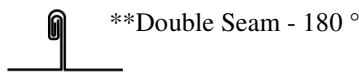

**Double Seam - 180 °

Style	Coverage	Gauge	Price
MI 150	16"	24	\$2.45 Ln Ft./ \$1.84 Per Sq. Ft.
MI 200	18"	24	\$2.55 Ln Ft./ \$1.70 Per Sq. Ft.
MI 210	17 5/8"	24	\$2.55 Ln Ft./ \$1.74 Per Sq. Ft.
1.5" Clip	Floating --	\$0.66	2" Fixed --\$0.35
2" Clip	Floating --	\$0.76	3" Fixed --\$0.50

Tested (varies by panel) in accordance with:

ASTM E1592 Uniform Static Air Pressure Uplift	UL Environmental - SRI Third Party Verified
ASTM E1646 Water Infiltration	UL 1897 Extended Phase Wind Uplift
ASTM E1680 Air Infiltration	UL 2218 Class 4 Hail Impact
ASTM E1886 Missile Impact	UL 263 Fire Certification
TAS 100 Wind Driven Rain	UL 790 Class A Fire Rating
TAS 125 Wind Uplift Test	UL 580 Wind Uplift (Class 90)
FM4471 Concentrated Load Foot Traffic	ASTM 2140 Static Pressure Water Head



Seamless Siding

- Much more durable than wood or vinyl
- Will not crack in cold temperatures
- Low maintenance
- Seamless (No end-lap joints)

Profile	Gauge	Price
Standard Lap	26	\$1.50/lf.
Dutch Lap	26	\$1.50/lf.
Board & Bat	26	\$1.50/lf.

Standard Lap

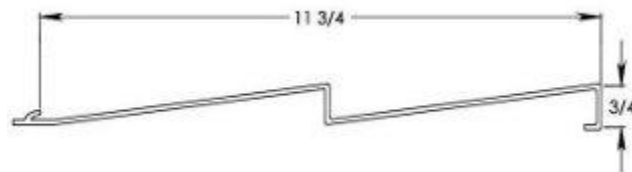

Dutch Lap

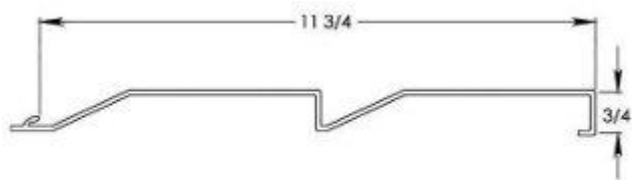

Board & Batt

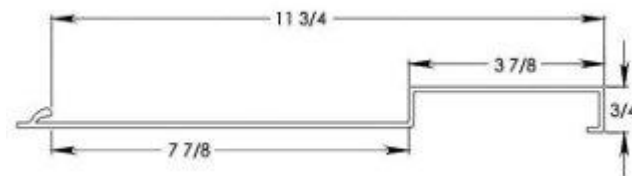

Standard Trim & Flashing

All trim is in 10'-3" lengths - up to 21'-3" lengths available. ***Specify pitch.**

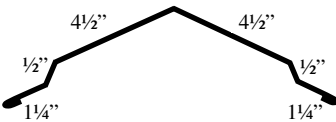
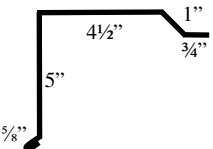
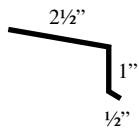
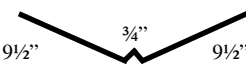
Ridge Cap* Painted / Bare 29 gauge \$16.00 / \$15.25 26 gauge \$22.00 / \$21.25 	Gable Trim Painted / Bare 29 gauge \$14.00 / \$13.25 26 gauge \$20.25 / \$19.50 	Eave Trim* Painted / Bare 29 gauge \$7.50 / \$7.25 26 gauge \$11.00 / \$10.75 	W Valley* Painted / Bare 29 gauge \$22.50 / \$21.75 26 gauge \$27.50 / \$26.75 
--	--	---	---

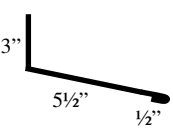
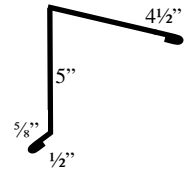
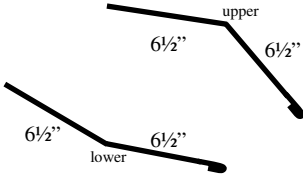
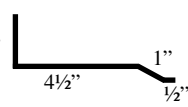
Endwall Trim* Painted / Bare 29 gauge \$11.50 / \$11.00 26 gauge \$17.00 / \$16.50 	Top Shed* Painted / Bare 29 gauge \$13.00 / \$12.25 26 gauge \$18.75 / \$18.00 	Pitch Change* Painted / Bare 29 gauge \$16.00 / \$15.25 26 gauge \$22.75 / \$22.00 	Sidewall Painted / Bare 29 gauge \$11.50 / \$11.00 26 gauge \$17.00 / \$16.50 
---	---	--	--

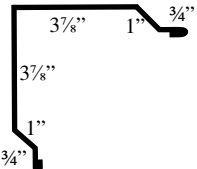
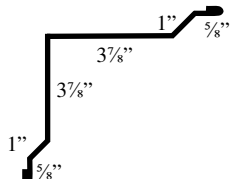
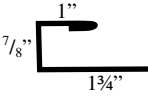
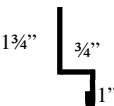
Outside Corner Painted / Bare 29 gauge \$15.00 / \$14.25 26 gauge \$20.50 / \$19.75 	Inside Corner Painted / Bare 29 gauge \$15.00 / \$14.25 26 gauge \$20.50 / \$19.75 	C Casing Painted / Bare 29 gauge \$7.50 / \$7.25 26 gauge \$11.00 / \$10.75 	Wall to Light Painted / Bare 29 gauge \$7.50 / \$7.25 26 gauge \$11.00 / \$10.75 
--	---	---	---

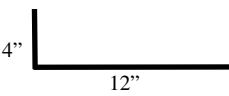
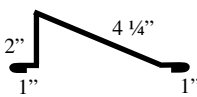
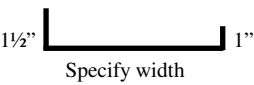
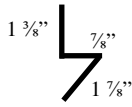
Upper Flash* Painted / Bare 29 gauge \$17.00 / \$16.25 26 gauge \$24.00 / \$23.25 	Snow Break Painted / Bare 29 gauge \$19.00 / \$18.50 26 gauge \$24.50 / \$24.00 	Jamb Cap 5 5/8" / 7 5/8" / 9 5/8" 29 g. Painted \$13.00 / \$14.00 / \$15.00 29 g. Bare \$12.50 / \$13.50 / \$14.50 26 g. Painted \$16.00 / \$17.00 / \$18.00 26 g. Bare \$15.50 / \$16.50 / \$17.50 	Rodent Guard Painted / Bare 29 gauge \$7.50 / \$7.25 26 gauge \$11.00 / \$10.75 
--	--	---	--

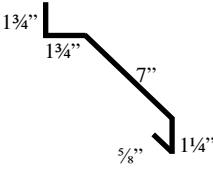
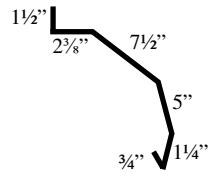
Track Cover Painted / Bare 29 gauge \$14.00 / \$13.25 26 gauge \$18.50 / \$17.75 	Double Track Cover Painted / Bare 29 gauge \$21.00 / \$20.25 26 gauge \$28.50 / \$27.75 
---	--

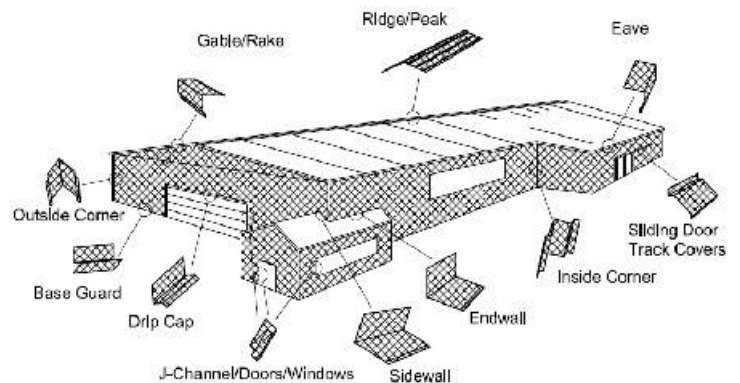

All trim is in 10'-3" lengths - up to 21'-3" lengths available. ***Specify pitch.**

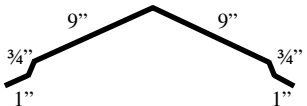
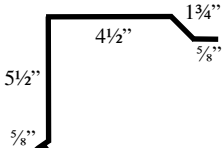
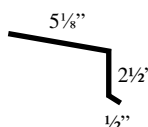
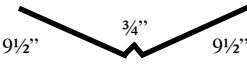
Ridge Cap* Painted / Bare 29 gauge \$18.50 / \$17.75 26 gauge \$28.00 / \$27.25 	Gable Trim Painted / Bare 29 gauge \$18.00 / \$17.25 26 gauge \$24.50 / \$23.75 	Eave Trim* Painted / Bare 29 gauge \$10.25 / \$9.75 26 gauge \$16.00 / \$15.50 	W Valley* Painted / Bare 29 gauge \$22.50 / \$21.75 26 gauge \$27.50 / \$26.75 
---	---	--	--

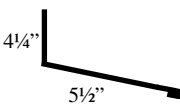
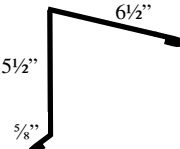
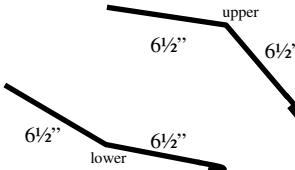
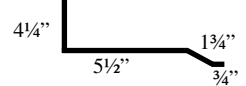
Endwall Trim* Painted / Bare 29 gauge \$12.00 / \$11.50 26 gauge \$16.50 / \$16.00 	Top Shed* Painted / Bare 29 gauge \$17.75 / \$17.00 26 gauge \$22.75 / \$22.00 	Pitch Change* Painted / Bare 29 gauge \$16.00 / \$15.25 26 gauge \$22.75 / \$22.00 	Sidewall Painted / Bare 29 gauge \$13.00 / \$12.50 26 gauge \$18.75 / \$18.25 
---	---	--	---

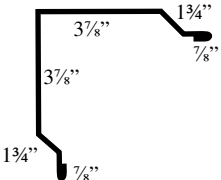
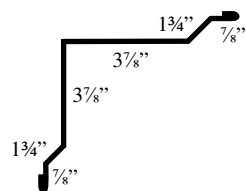
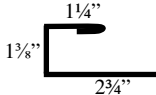
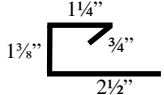
Outside Corner Painted / Bare 29 gauge \$20.00 / \$19.25 26 gauge \$26.00 / \$25.25 	Inside Corner Painted / Bare 29 gauge \$20.00 / \$19.25 26 gauge \$26.00 / \$25.25 	Open C Casing Painted / Bare 29 gauge \$9.25 / \$9.00 26 gauge \$11.50 / \$11.25 	Closed C Casing Painted / Bare 29 gauge \$9.25 / \$9.00 26 gauge \$11.50 / \$11.25 
---	---	---	--

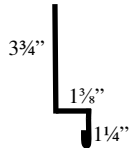
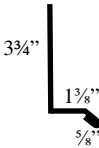
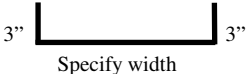
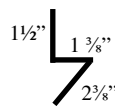
Wall to Light Flash Painted / Bare 29 gauge \$8.00 / \$7.75 26 gauge \$11.00 / \$10.75 	Base Trim Painted / Bare 29 gauge \$8.00 / \$7.75 26 gauge \$11.00 / \$10.75 	Jamb Cap 6" / 8" / 10" 29 g. Painted \$13.75 / \$15.50 / \$18.00 29 g. Bare \$13.25 / \$15.00 / \$17.50 26 g. Painted \$16.50 / \$18.00 / \$20.00 26 g. Bare \$16.00 / \$17.50 / \$19.50 3" _____ 3" Specify width 	Rodent Guard Painted / Bare 29 gauge \$7.00 / \$6.75 26 gauge \$10.25 / \$10.00 
---	--	--	---

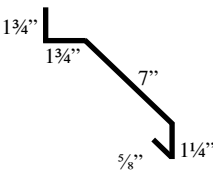
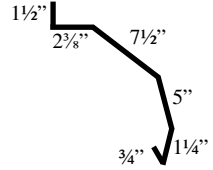
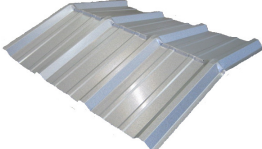
Track Cover Painted / Bare 29 gauge \$14.00 / \$13.25 26 gauge \$18.50 / \$17.75 	Double Track Cover Painted / Bare 29 gauge \$21.00 / \$20.25 26 gauge \$28.50 / \$27.75 	PBR Formed Ridge Painted / Bare 26 gauge only \$15.50 / \$14.50  36" x 36" coverage	Custom Trim \$1.50 per bend + \$0.75 per inch of girth - 29 gauge or \$1.00 per inch of girth - 26 gauge
--	---	--	--

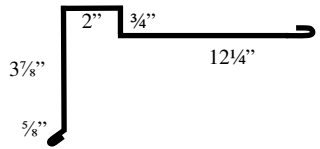
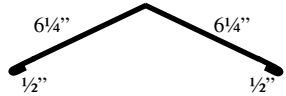
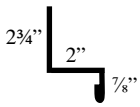
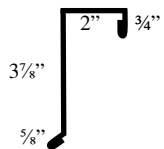
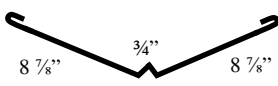
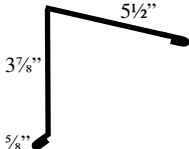

Loc Seam Trim & Flashing

All trim is in 10'-3" lengths - up to 21'-3" lengths available. ***Specify pitch.**

Prow Gable Trim Painted/Bare 29 gauge \$23.00 / \$22.25 26 gauge \$32.00 / \$31.25 	Hip Cap* Painted/Bare 29 gauge \$15.00 / \$14.25 26 gauge \$22.50 / \$21.25 	Loc Seam Sidewall Painted/Bare 29 gauge \$11.00 / \$10.50 26 gauge \$14.00 / \$13.50 
Loc Seam Gable Painted/Bare 29 gauge \$13.00 / \$12.50 26 gauge \$18.75 / \$18.25 	Loc Seam W Valley* Painted/Bare 29 gauge \$23.00 / \$22.25 26 gauge \$29.00 / \$28.25 	Loc Seam Top Shed* Painted/Bare 29 gauge \$13.00 / \$12.25 26 gauge \$18.75 / \$18.00 

Chimney & Skylight Flashing

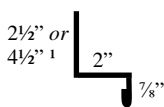
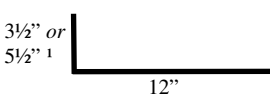
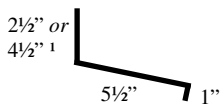
All trim is in 10'-3" lengths - up to 21'-3" lengths available. ***Specify pitch.**

Sidewall Painted/Bare 29 gauge \$11.00 / \$10.50 26 gauge \$14.00 / \$13.50 	Upper Flash* Painted / Bare 29 gauge \$17.00 / \$16.25 26 gauge \$24.00 / \$23.25 	Lower Flash* Painted / Bare 29 gauge \$11.50 / \$11.00 26 gauge \$17.00 / \$16.50 	Chimney Counterflash Painted/Bare 29 gauge \$12.00 / \$11.50 26 gauge \$14.50 / \$14.00 
¹ Specify curb height	¹ Specify curb height	¹ Specify curb height	

Trim Locations

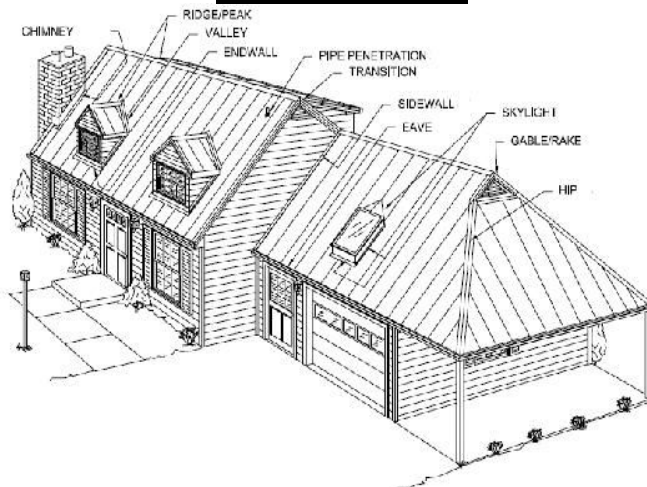

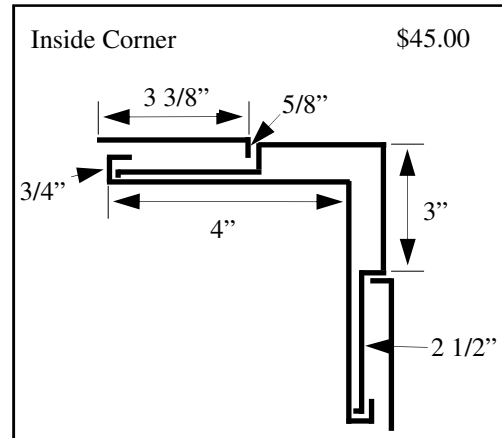
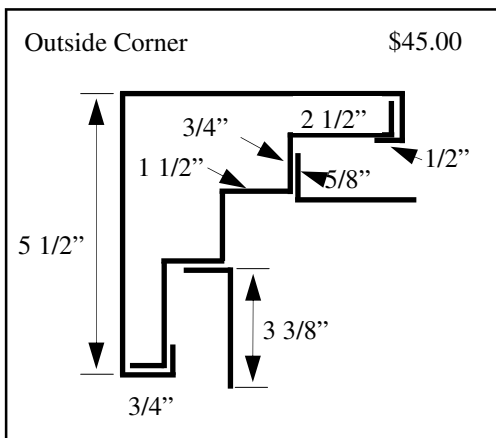
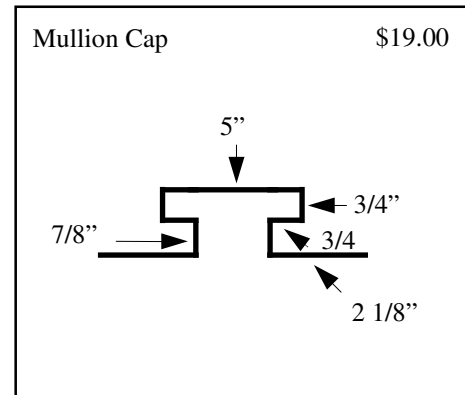
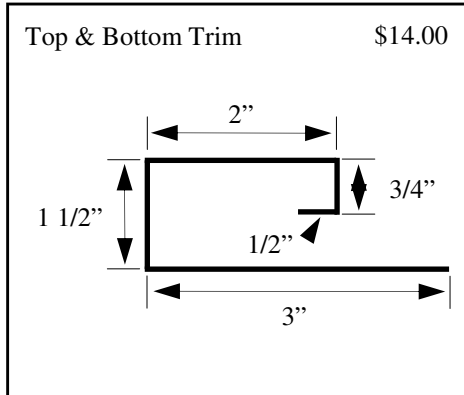
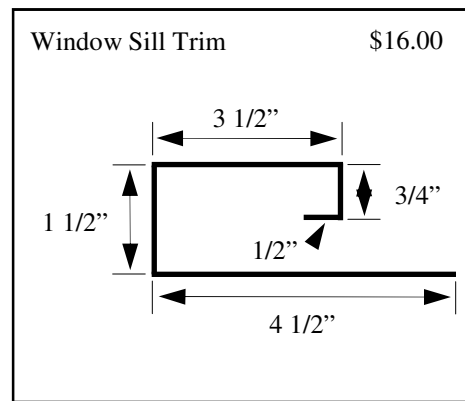
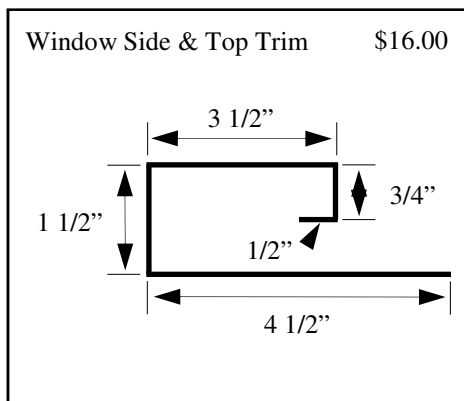
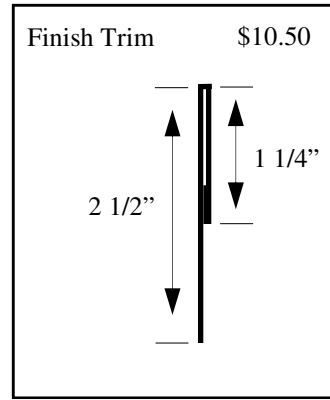
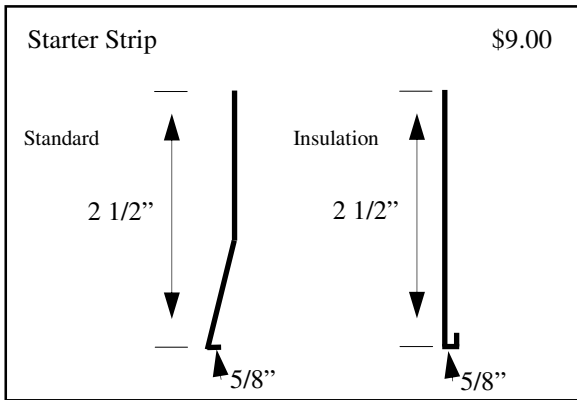

Model 2400:

- Designed for moderate commercial use
- Value priced choice
- Nominal 24 gauge steel construction

Model 24 gauge:

- True 24 gauge steel construction
- High Strength for heavy-duty use

Both models:

- Standard White smooth finish
- Standard poly laminate on back of insulated door - 30 gauge steel back is available
- Insulation R-value 7.6
- Many options available

Model 2400 Non-insulated

Height> Width	7/8	9/10	11/12	13/14
8'	\$455	\$525	\$650	\$770
9'	\$485	\$570	\$710	\$800
10'	\$505	\$590	\$735	\$830
11'	\$545	\$655	\$775	\$875
12'	\$565	\$675	\$800	\$905
13'	\$675	\$800	\$940	\$1,100
14'	\$675	\$800	\$940	\$1,100
15'	\$770	\$905	\$1,095	\$1,245
16'	\$770	\$905	\$1,095	\$1,245

Model 2400 Insulated

Height> Width	7/8	9/10	11/12	13/14
8'	\$550	\$645	\$805	\$915
9'	\$620	\$730	\$910	\$1,060
10'	\$645	\$770	\$950	\$1,100
11'	\$690	\$835	\$990	\$1,155
12'	\$690	\$835	\$990	\$1,155
13'	\$865	\$1,025	\$1,230	\$1,420
14'	\$865	\$1,025	\$1,230	\$1,420
15'	\$950	\$1,120	\$1,370	\$1,560
16'	\$950	\$1,120	\$1,370	\$1,560

24 Gauge Non-insulated

Height> Width	7/8	9/10	11/12	13/14	15/16	17/18
8'	\$470	\$545	\$685	\$810	NA	NA
9'	\$505	\$605	\$735	\$855	NA	NA
10'	\$520	\$625	\$770	\$870	NA	NA
11'	\$575	\$685	\$815	\$920	NA	NA
12'	\$595	\$705	\$840	\$975	\$1,355	\$1,395
13'/14'	\$715	\$840	\$1,015	\$1,160	\$1,495	\$1,580
15'/16'	\$790	\$950	\$1,145	\$1,315	\$1,585	\$2,535
17'/18'	\$905	\$1,075	\$1,295	\$1,630	\$2,155	\$2,980
19'/20'	\$1,155	\$1,450	\$1,655	\$1,895	\$2,515	\$3,030

24 Gauge Insulated

Height> Width	7/8	9/10	11/12	13/14	15/16	17/18
8'	\$570	\$680	\$830	\$970	NA	NA
9'	\$635	\$765	\$940	\$1,095	NA	NA
10'	\$665	\$800	\$985	\$1,150	NA	NA
11'	\$725	\$870	\$1,045	\$1,180	NA	NA
12'	\$810	\$955	\$1,050	\$1,190	\$1,570	\$1,745
13'/14'	\$895	\$1,070	\$1,285	\$1,480	\$1,795	\$2,170
15'/16'	\$970	\$1,200	\$1,420	\$1,625	\$2,355	\$2,940
17'/18'	\$1,130	\$1,365	\$1,640	\$2,345	\$2,480	\$3,365
19'/20'	\$1,510	\$1,765	\$2,050	\$2,565	\$3,035	\$3,970



America's Favorite Garage Doors®

- Embossed 25 gauge steel panels
- 15 year paint system
- Five factory finish paint colors
- Tongue-and-groove section joints
- 2" thick frame construction
- Woodgrain textured short and long raised panel designs
- Model T52: Polystyrene vinyl-backed insulation, R-value 6.3
- Many window options available
- Call us for custom size availability

Model T50 Non-insulated

Height> Width	7'	8'	9'	10'	12'	14'	16'
	8'	\$330	\$385	\$520	\$545	\$640	\$725
9'	\$350	\$400	\$540	\$560	\$670	\$760	\$865
10'	\$400	\$425	\$570	\$595	\$695	\$795	\$905
12'	\$450	\$530	\$725	\$760	\$900	\$1,025	\$1,170
14'	\$470	\$570	\$775	\$805	\$955	\$1,090	\$1,245
15'	\$510	\$605	\$825	\$865	\$1,025	\$1,170	\$1,340
16'	\$535	\$625	\$860	\$890	\$1,050	\$1,200	\$1,370

Model T52 Insulated

Height> Width	7'	8'	9'	10'	12'	14'	16'
	8'	\$395	\$460	\$595	\$615	\$715	\$815
9'	\$415	\$485	\$625	\$645	\$765	\$870	\$990
10'	\$475	\$555	\$650	\$680	\$795	\$905	\$1,035
12'	\$605	\$685	\$830	\$870	\$1,020	\$1,165	\$1,330
14'	\$620	\$705	\$885	\$925	\$1,085	\$1,240	\$1,420
15'	\$635	\$750	\$945	\$985	\$1,160	\$1,325	\$1,515
16'	\$635	\$755	\$1,025	\$1,060	\$1,250	\$1,430	\$1,635

Door Installation Prices



	Price	Price
Item	Residential	Commercial
Overhead Door Delivery	\$50.00/ea.	\$50.00/ea.
Overhead Door Install (\$150.00 min.)	\$1.75/sq.ft.	\$1.75/sq.ft.
Operator Install	\$250.00	\$250.00
High-lift Track Install	\$50.00	\$50.00
Low Headroom Track Install	\$50.00	\$50.00
Pre-existing Door Removal & Disposal	\$200.00	\$200.00
Dirt Floor Surcharge	\$35.00	\$35.00
Trip Charge (outside of 25 mile radius) \$50.00 minimum	50.00	50.00

Dutch/Bale Doors



- Fabricated from 16 ga. Galvaneal
- Feature one piece cut laser design
- Standard D-Latch
- 3-piece frame prepped with hinges
- *Price does not include freight - call for freight quote
- Assembled Premium Dutch & bale doors include: One piece laser cut door panels, Cross bucks, 29 ga. Steel insert, Plywood core, Hinges, Barrel bolt, D-Latch, Fasteners & Door Catch



		Price*	Price*
Item	Rough Opening	Standard	W/Window
Dutch Door	49 1/8" x 87 1/2"	\$1,125.00	\$1,508.00
Bale Door	49 1/8" x 43 3/4"	\$677.00	\$1,087.00





Sliding Door Kits





All Kits include:



Track, Trolley Set, Track cover Brackets, Side Rails, Adjustable Offset Stay Roller, Door Pull, 7 1/2" Cam Latch, 2 Adjustable Door Stops



Size	Price
4' x 8'	\$205.76
10' x 10'	\$288.24
12' x 12'	\$326.78
14' x 14'	\$365.32

Round Track Topmount \$5.11/lf.  Available in 8' - 14' Lengths in 2' multiples	Round Track Facemount \$5.11/lf.  Available in 8' - 14' Lengths in 2' multiples	Round Track Studmount \$5.11/lf.  Available in 8' - 14' Lengths in 2' multiples	Trolley Set 9" Offset Bolt \$43.97  600lb. Rating	Splice Collar \$3.06 
---	--	--	---	--

Double Track Support w/ Welded Bracket \$10.40 	Double Track Side-mount Bracket \$6.75 	Single Track Adjustable Bracket \$5.75 	Standard Track Cover bracket \$1.19 
--	--	---	---

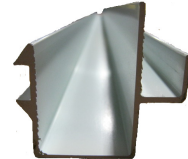
Adjustable Offset Stay Roller \$11.69 	Small Adjustable Stay Roller \$10.46 	12" Cane Bolt \$12.47 	White Aluminum Side Rail \$3.93/lf  Available in 8', 10', 12', 14', 16'
---	--	--	---

Non-adjustable Door Stop \$7.54 	Adjustable Door Stop \$10.09 	Bi-pass Door Guide \$20.61 	White Aluminum Side Rail w/adaptor \$4.94/lf  Available in 8', 10', 12', 14'
---	--	---	--

6" Gate Hook \$7.08 	Sliding Bolt Latch \$14.08 	Cam Latch \$13.46  Adjustable cam action	White Door Pull \$3.98 
---	--	---	--

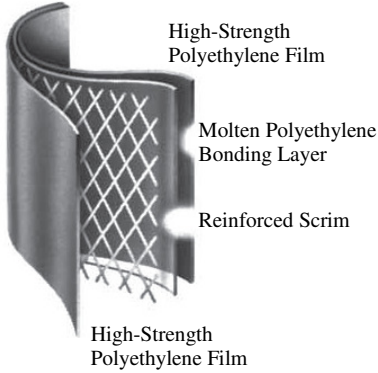

Dura-Skrim®

- Excellent choice as an in-wall and roof vapor retarder
- Heavy-duty scrim reinforcement, laminated between two layers of virgin high-strength polyethylene film
- Resists punctures and immediately stops tears
- Accordion folded and tightly rolled on a heavy-duty core for ease of handling and time-saving installation
- UV stabilizers increase longevity
- 6 mil thickness



Size	R-Value	Price
6' x 100'	none	\$78.00
12' x 100'	none	\$156.00

Low - E Vapor Plus and Low-E Foil

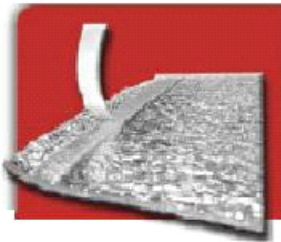

- Saves time and money
- Non - toxic — No fiberglass
- Seals tight around fasteners
- Certified ASTM testing
- Microcell polyethylene foam construction
- Improve energy efficiency
- Vapor barrier and thermal break all in one

Size	R-Value	Price	
4' x 100'	7-10	\$.425/sq. ft.	\$170/roll
4' x 100'	3-4	\$.388/sq. ft.	\$155/roll

Felt Paper

- Manufactured from premium quality organic mat and saturated with high-grade asphalt
- Dimensions: 3' x 72'
- Approx. weight per roll: 35 lbs.

Type	Price
30# Non-ASTM	2 square roll - \$19/roll

Safeguard 30 Synthetic Underlayment

- Hybrid technology combines asphaltic polymer & synthetic fabrics
- Slip-resistant
- Meets or Exceeds ASTM D226
- 30 year warranty
- Thermal stability in excess of 260 F
- Dimensions: 3' x 145', 50# per roll

Type	Price
Safeguard 30	4.5 square roll - \$60/roll

Ice & Watershield

- Modified rubberized asphalt Peel & Stick underlayment
- 30 year limited warranty
- 240°F temperature rating
- Slip-resistant technology
- Self-seals around nails
- Dimensions: 3' x 72', 48# per roll

Type	Price
Ice & Watershield	2 square roll - \$105/roll

Condensation Control Blanket

- Helps reduce exterior / interior noise
- Eliminates drafts
- Available in cut-to-length
- Allow 1 week notice



Width	Thickness	R-Value	Price
4' or 6'	1 1/2"	3-4	\$0.35/sq. ft.
4' or 6'	3"	10	Call for pricing
4' or 6'	4"	13	Call for pricing
4' or 6'	6"	19	Call for pricing



Master Flash



Retrofit

“When over the top is not an option”



Hi - Temp

Black EPDM

- Great for residential or commercial
- Forms over virtually any profile
- Withstand up to 212 deg.
- Maximum resistance to UV rays and weathering
- Base flexibility
- Easy on-site customization
- Available in custom color
- Retrofit is useful for electrical weatherheads

Model	Size	Price
# 2	1 1/4" - 3"	\$12.00
# 3	1/4" - 4"	\$14.00
# 4	3" - 6"	\$23.00
# 6	5" - 9"	\$31.00
# 7	6" - 11"	\$40.00
# 8	7" - 13"	\$54.00
# 9	10" - 18"	\$108.00
# 10	13" - 26"	\$175.00
# 1 Retrofit	1" - 4"	\$42.00

Hi-Temp Silicone Pipe Flash

- Great for heat vents and stove pipes
- Temp range of -100 deg. to +500 deg.

Model	Size	Price
# 4 Hi-temp	3" - 6"	\$40.00
# 5 Hi-temp	4" - 7"	\$50.00
# 6 Hi-temp	5" - 9"	\$55.00
# 7 Hi-temp	6" - 11"	\$75.00
# 8 Hi-temp	7" - 13"	\$95.00
#9 Hi-temp	9-1/2" - 20-1/2"	\$170.00

Light Panels

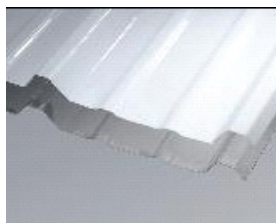

Polycarbonate

- Up to 20% stronger than fiberglass
- 100% U.V. Protection
- 90% light transmission
- Clear as glass . . . won't yellow with age
- Custom cut to nearest 1 inch increments
- Available in White and Clear

Profile	Price
3' Magna Rib	\$3.75/lf.
3' PBR	\$4.25/lf.



Fiberglass

- 26% U.V. protection
- Allows 66% light transmission
- Great for Sky-lights and decks
- Available in 8', 10', or 12'

Profile	Price
2' Corrugated	\$3.50/lf.
2' Delta	\$3.50/lf.
3' Magna Rib	\$4.86/lf.
3' PBR	\$7.00/lf.